



NPS

OWNER'S GUIDE

Model Y4500/Y5500

Introduction

Welcome to N.P.S. Company, LLC's (NPS) Owner's Guide (Guide) for the NPS Generator Models Y4500 and Y5500U (Generator). These Generators are designed with your comfort and ease in mind. NPS is proud to provide these Generators to enhance your experience in the outdoors and the wild places of this planet.

NPS is dedicated to ensuring you will be able to focus on the adventures at hand and will have peace of mind knowing your recreational vehicle (RV) will have Generator power when and where you need it.

This Guide will provide you with an overview of the safety issues and precautions you will need to be aware of while operating, maintaining and storing the Generator with your RV. Safety is of utmost importance and failure to follow this Guide may result in performance degradation of the Generator and extreme bodily injury to the owner. The Safety section below is followed by information, photos and details specific to your Generator to help you make the most of your adventures and prolong the life of your unit.

This Guide should be used for NPS Generator Models Y4500 and Y5500U only.

A. Safety

A.1 Throughout this Guide, you will see several warnings repeated to alert the Generator owner or operator to existing and potential hazards. These warnings are in place to ensure the safety of the Generator owner or operator.

A.2 Safety is of utmost importance and failure to follow the procedures as set forth in this Guide could result in performance failure of the Generator and severe bodily injury or death to the owner or operator.

A.3 These warnings will include:



DANGER: Indicates an immediate hazard, which if not avoided, will result in death or extreme bodily injury to installer or operator.



WARNING: Indicates a hazard level between caution and danger and indicates a hazardous situation, which if not avoided, could result in death or serious bodily injury to installer or operator.



CAUTION: Indicates a potential hazard, which if not avoided may result in minor or moderate bodily injury to installer or operator.

A.4 Other words requiring attention and/or action, as stated include:

HAZARD	MANDATORY ACTION
ALERT	SAFETY PROCEDURES
SAFETY INSTRUCTIONS	SAFETY SHUTDOWN PROCEDURES
PROHIBITION INFORMATION	ATTENTION

A. Safety

WARNING

PROHIBITION

A.5 Do not attempt to service or repair Generator:

- Unless you are mechanically knowledgeable and experienced or are being supervised by a qualified technician
- When physically tired or mentally weary
- If alcohol has been consumed within previous twenty-four (24) hour period
- If drugs have been consumed or administered, including prescription drugs which in any way alter normal physical functioning or mental capacity with-in previous twenty-four (24) hour period
- While smoking
- If children or pets are in close proximity to service or maintenance area
- While wearing jewelry on hands, wrists or around neck
- While wearing loose clothing which could fall into or be caught by moving parts in, or around Generator
- While Generator is running

WARNING

MANDATORY ACTION

A.6 Required prior to commencement service or maintenance:

- Locate and keep multi-class ABC fire extinguishers within reach of RV and readily available at all times
- Determine, locate and wear personal protective equipment (PPE) necessary for Generator service and maintenance, including but not limited to safety glasses, as required by NPS
- Verify negative (-) battery cable is disconnected at the battery (or batteries), prior to performing maintenance. Always disconnect the negative (-) battery cable first and only reconnect it after maintenance or repairs have been fully completed to prevent unplanned starting or arcing while working on the Generator
- Locate and identify all moving parts including fans, belts, pulleys, hinged covers, etc., to raise awareness of potential hazard areas in and around the Generator
- When working in an enclosed space, locate and verify operational carbon monoxide and smoke detector(s) in the service area

A. Safety

WARNING

HAZARD ALERT

A.7 Gasoline is flammable and explosive:

- Keep multi-class ABC fire extinguisher(s) within reach and readily available throughout the service or maintenance process
- Do not smoke or permit others to smoke at or near repair or maintenance location
- Any rags soiled with gasoline or oil must be discarded in fire proof container
- Routinely check for leaks and collections of gasoline pooling in the service area
- Secure and shield fuel lines separately and away from electrical wiring and/or ignition wiring to prevent accidental fire and/or explosion
- Keep all ignition sources away from fuel lines including:
 - open flames
 - arc producing equipment
 - sparks
 - pilot lights
 - electrical switches



DANGER

A.8 Engine Exhaust:

Gasoline-powered engines and tools present a serious health hazard. They produce high concentrations of carbon monoxide (CO). CO is a poisonous gas that can cause illness, permanent neurological damage and death. CO is colorless, odorless, and non-irritating and therefore can overcome exposed persons without warning. CO can rapidly accumulate (even in areas appearing to be well ventilated).

A.9 Review [cdc.gov/niosh/topics/co/default.html](https://www.cdc.gov/niosh/topics/co/default.html) for additional precautions and recommendations regarding "Carbon Monoxide Hazards from Small Gasoline Powered Engines"

A.10 Read and understand the OSHA Fact Sheet and Quick Reference Sheet for Carbon Monoxide Poisoning

https://www.osha.gov/OshDoc/data_General_Facts/carbonmonoxide-factsheet.pdf

<https://www.osha.gov/Publications/3282-10N-05-English-07-18-2007.html>

A. Safety

A.11 Failure to follow the service and maintenance procedures as set forth in this Owner's Guide may void NPS' Limited Warranty and result in death or extreme bodily harm to owner or operator

A.12 Do not operate Generator in an enclosed space such as a garage or storage stall

A.13 Ensure RV is equipped with working CO detector

A.14 Verify CO and smoke detector(s) are functioning properly while the Generator is operating

A.15 Inspect entire Exhaust Assembly and Exhaust Support Strap and verify fittings are tight and secure and pipe opening is free of debris or other obstructions at initial start-up and after every ten (10) hours of operation

A.16 Inspect and ensure CO and/or smoke detectors are operating properly at every start-up and replace batteries at intervals recommended by CO detector manufacturer for RVs



DANGER

A.17 Generator Voltage Arc-Flash and Electrical Shock Hazard

MANDATORY ACTION: Prior to performing any work on the Generator, all electrical connections must be identified and designated as either energized or non-energized to all service team members. Verification of energized or non-energized connection(s) or surfaces must be constantly monitored by a qualified technician

A.18 Test equipment shall be used to ensure that electrical parts and circuit elements have been de-energized prior to performance of any and all Generator service or maintenance

A.19 Testing instruments and equipment shall be visually inspected for external defects or damage before being used to determine de-energization (29 CFR 1910.334(c)(2))

A. Safety



DANGER

A.20 Generator Voltage Arc Flash and Electrical Shock Hazard:

Prior to working on live electrical equipment:

- Disconnect shore power to RV
- Disconnect negative (-) terminal battery or batteries
- Remove any metal or conductive apparel. Articles of jewelry and clothing such as metal: watch bands, bracelets, rings, keychains, necklaces, ear or other metal piercings, metalized aprons, cloth with conductive thread, or metal headgear shall not be worn. (29 CFR 1910.333(c)(8))
- NPS recommends working on a dry non-conductive material
- Ensure clothes, hands and hair are dry

A.21 Condition specific PPE, including safety glasses, must be worn to protect eyes and face from electric arcs, flashes or from flying objects resulting from an electrical explosion

A.22 Use only tools with non-conductive and/or non-combustible covered handles

A.23 Electrical connections shall be made by a qualified person experienced and familiar with construction and operation of electrical equipment and the hazards involved. Qualified persons are intended to be only those well acquainted with and thoroughly conversant in electric equipment and electrical hazards involved with work being performed

A.24 Review placard and warnings on Generator for amperage and voltage information to protect installers and operators from hazards which could cause injury due to electric shock, burns or failure of electrical components.

CAUTION

A.25 Visually inspect all Generator mounting components (Exhaust Assembly, Service Access Door, Fuel Connections, Electrical Connections, Remote Control Panel) every ten (10) hours of operation.

WARNING

A.26 NPS' Generator is not designed to be a primary source of power for life support systems or devices but can support temporary operating or charging of recreational or battery powered components.

B. Getting to know your Generator

B.1 NPS Generator Models Y4500 and Y5500U are designed with the following features and benefits:

- Partnered with and Powered by Yamaha
- NPS' Yamaha-backed Limited Warranty
- Pure sine wave inverter technology providing clean, safe and stable power
- Enhanced fuel efficiency
- Advanced cooling system
- Integrated pull-start
- Hand-held remote-start keyfob
- Largest Network of Service Locations

B.2 NPS Generator(s) provides AC Power to applicable components

B.3 This Guide will walk you through the following features and attributes of the NPS Generator Models Y4500 and Y5500U, where they can be found, how they work, how to operate and when to service

- **NPS Generator** See [Exhibit 1](#)
- **Generator Components Located within Service Access Door** See [Exhibit 2](#)
- **Generator Exhaust Assembly** See [Exhibit 3](#)
- **Generator Base** See [Exhibit 4](#)
 - Location of Air Intake and Air Outflow
 - Rubber Isolation Strips for anti-vibrations
- **Generator Fuel Line and Vapor Purge Line** See [Exhibit 5](#) (applicable to non-powered RV installations)

WARNING

- **Never store anything underneath or around the bottom or front of the Generator. Lack of a proper ventilation parameter may cause the Generator to overheat and/or ignite tall grass, vegetation or other objects in proximity to the running Generator. This presents a fire hazard which could ignite from hot exhaust pipe assembly, fumes and vapors and result in death or extreme bodily harm to the Owner or Operator.**

WARNING

- **Maintain a proper ventilation parameter extending 914.4 mm or (3') in all directions from all manufacturer installed Generator components.**

B. Getting to know your Generator

B.3 (continued)

- **Pre-Start Check and Inspection**
- **Starting and Operating the Generator**
- **Maintenance Requirements**
- **Trouble Shooting**
- **NPS' Limited Warranty**
- **Specifications**
- **Maintenance Record**

Exhibit 1 - NPS Generator

Generator Service Access Door
(closed position)

Generator Service Access Door Latches

Generator
Casing

Warning Tags

Generator
Model Number

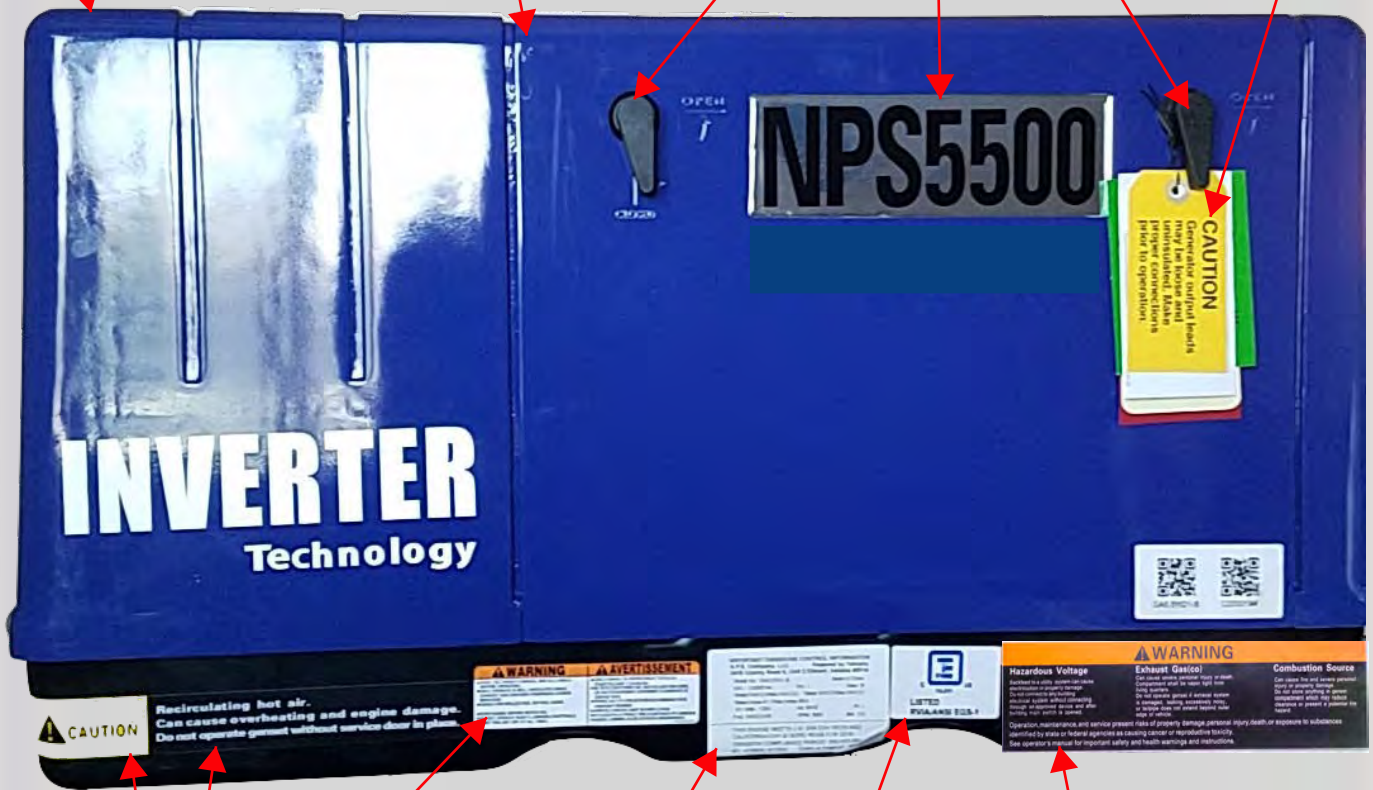

Generator
Base

Warning
Labels

Generator
Nameplate

Warning Label

NPS' TEI United States
and Canada Certification
Mark

C. Generator Components Located within Service Access Door

C.1 Generator Components Located within Service Access Door See [Exhibit 2](#)

- Fault Indicator Lights
- Carburetor Fuel Drain
- Carburetor
- Hand-held Remote-Start Keyfob (NPS original transport location)
- Automatic Engine Choke
- Engine Air Filter Housing
- Emergency Pull-Start Handle
- Generator Service Access Door Opening
- Warning Labels
- Engine Oil Dipstick
- Engine Oil Drain Plug
- Control Panel
- Nameplate
- NPS' TEI United States and Canada Certification Mark
- Master 12Volt Power Switch
- 12Volt Battery Connection (Positive) (+)
- 12Volt Circuit Breaker

C.2 Nameplate provides the following information See [Exhibit 2](#)

- Manufacturer Name and Contact Information
- Emissions Control and Compliance
- Generator Model Number
- Serial Number
- Rating
- Voltage
- Required Fuel: Unleaded Gasoline

C. Generator Components Located within Service Access Door

C.3 Control Panel See [Exhibit 2](#)

- Start/Stop Prime Switch
- Oil Alert fault indicator light
- Overload Alarm fault indicator light
- Locater arrows for the 30amp AC Circuit Breaker

C.4 Warning Labels are located on and around the Generator to alert the Owner to location specific hazards associated with operating, servicing and maintaining the Generator. See [Exhibit 1](#), [Exhibit 2](#) and [Exhibit 3](#)

Exhibit 2 - Generator Components Located within Service Access Door

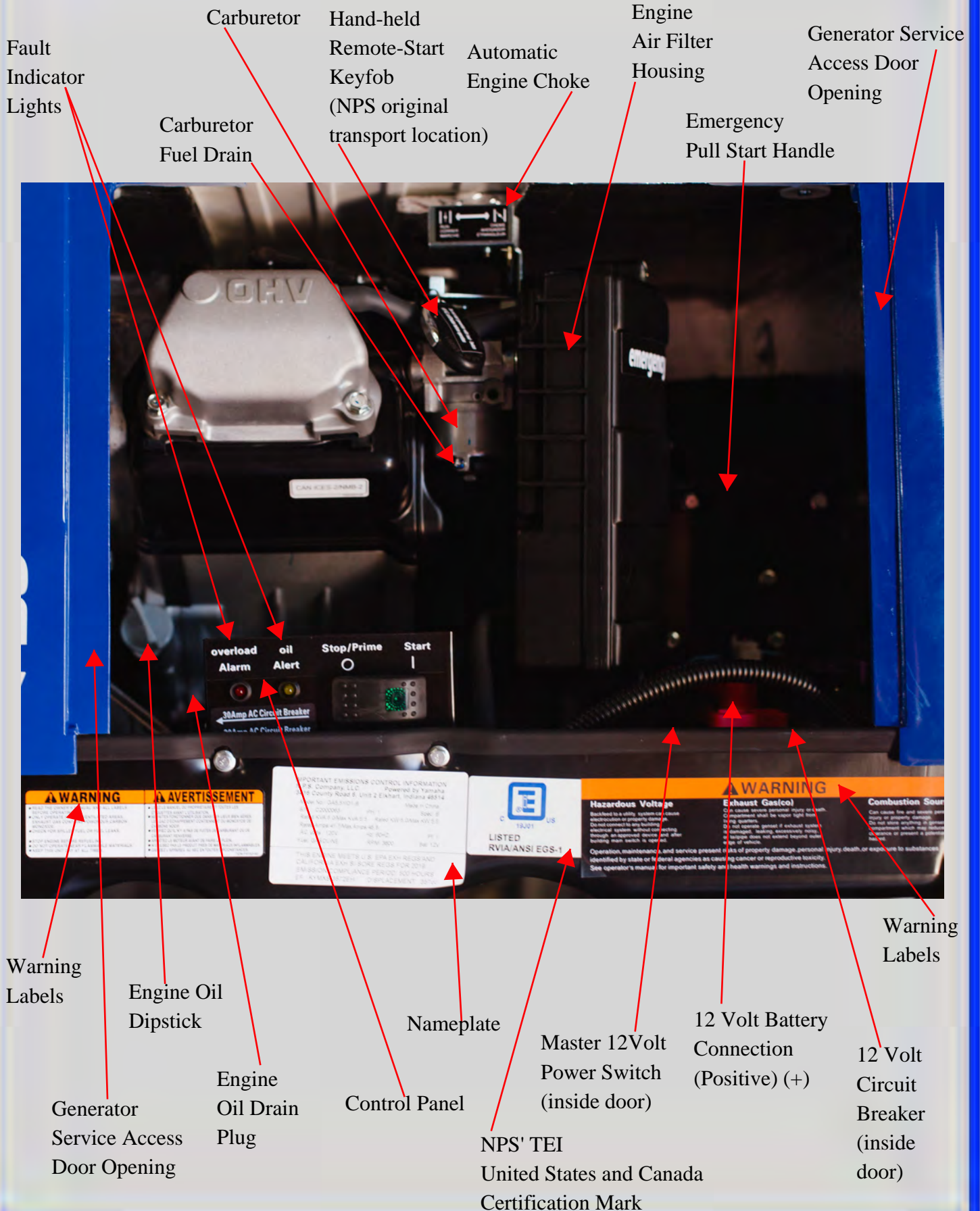

Exhibit 3 - Generator Exhaust Assembly

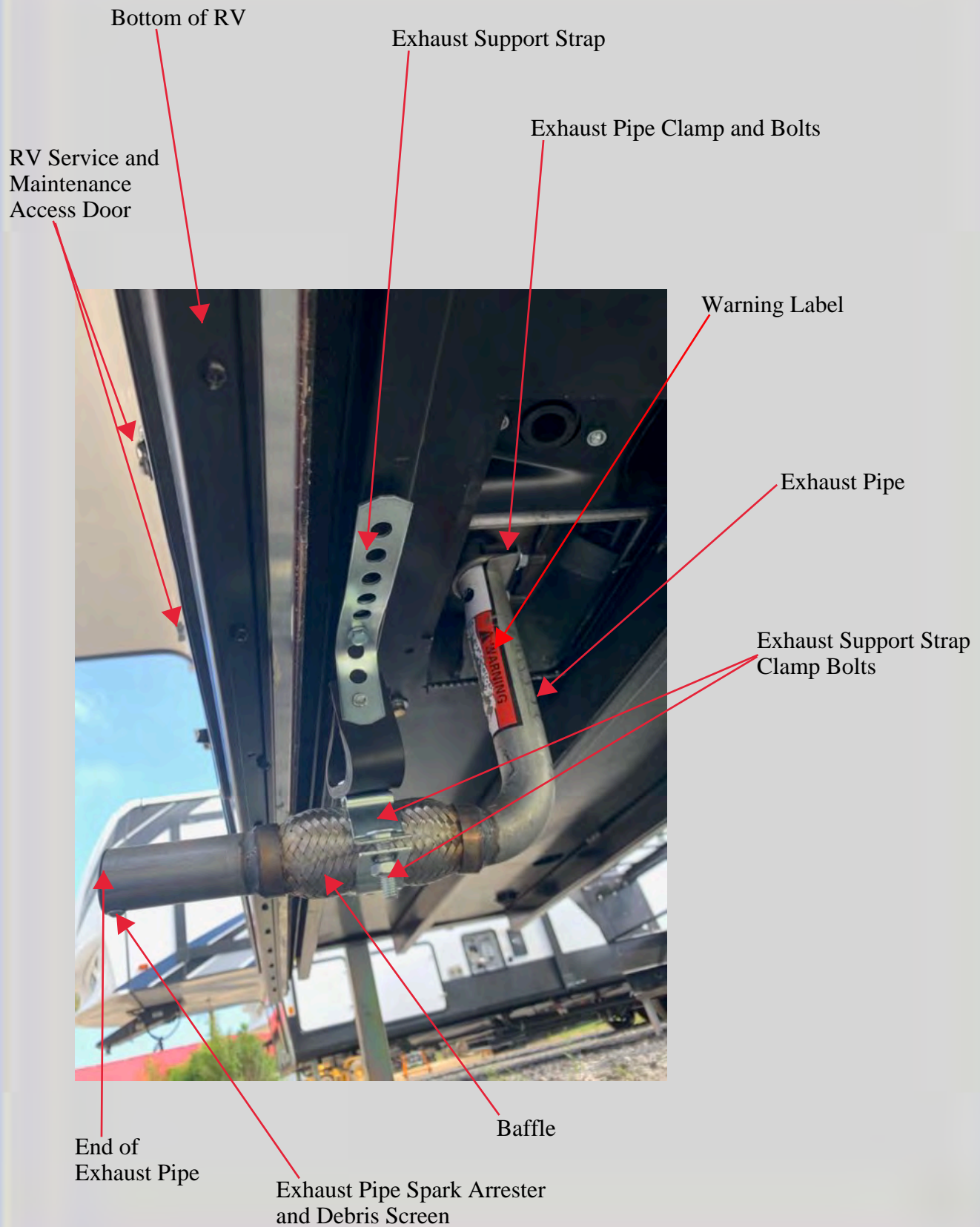

Exhibit 4 - Generator Base

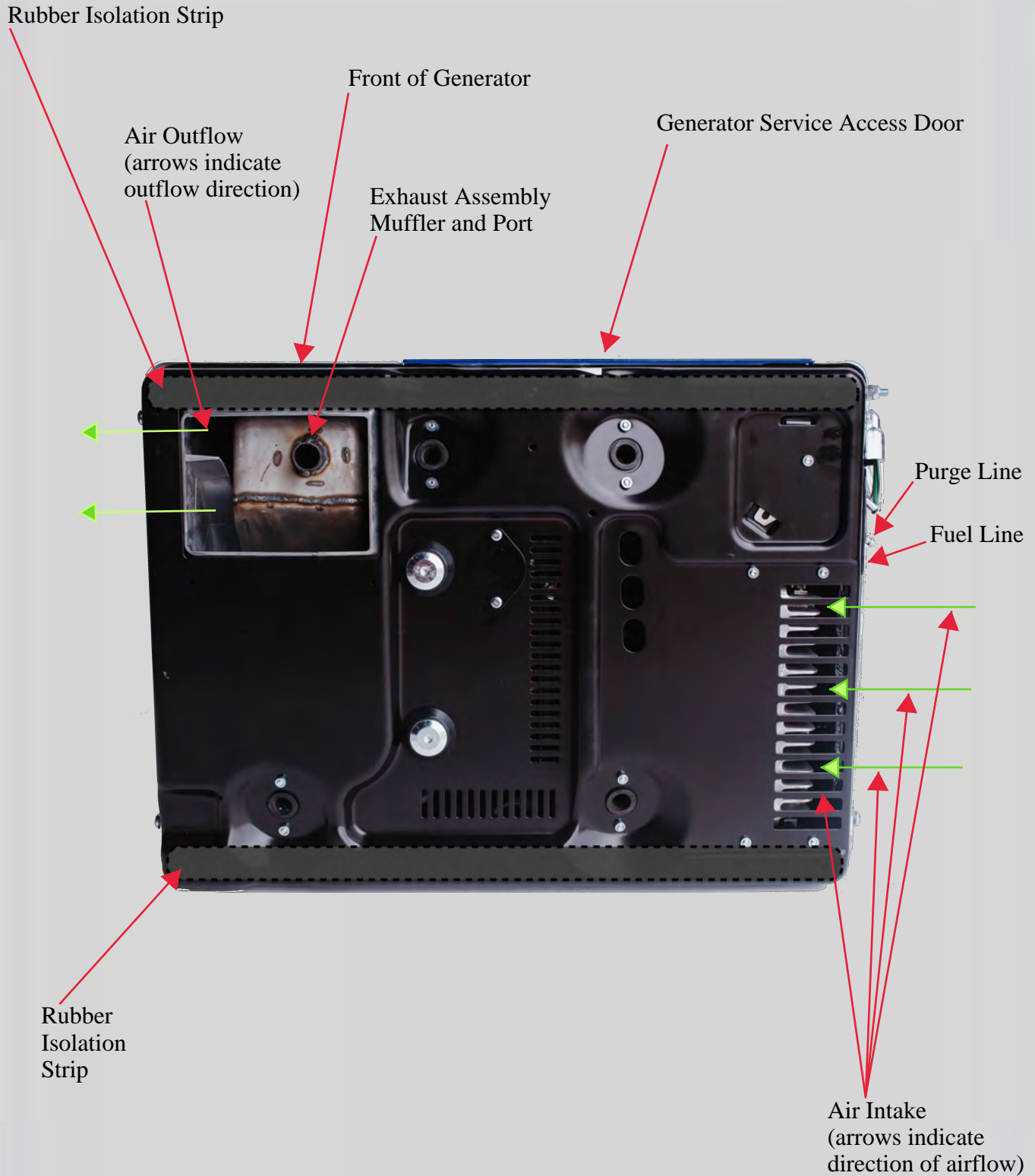

Exhibit 5 - Generator Fuel Line and Vapor Purge Line



D. Pre-Start Check and Inspection

D.1 Battery and Battery Connections

Verify there is sufficient battery voltage. Ensure all battery connections are clean of any acid build-up and battery cable nuts are securely fastened.

D.2 Locate, Open and Secure the RV Generator Compartment Door

D.3 Locate, Open and Remove Generator Service Access Door and set aside while performing remainder of Pre-Start Check and Inspection

D.4 Oil Level

- Ensure RV is on a level surface
- Remove the engine oil dipstick from engine
- Wipe off all excess oil from dipstick
- Re-insert engine oil dipstick without threading in dipstick
- Immediately remove and verify oil on dipstick is at FULL mark

D.5 Fuel Level and Connections

WARNING

- **Never store anything underneath or around the bottom or front of the Generator. Lack of a proper ventilation parameter may cause the Generator to overheat and/or ignite tall grass, vegetation or other objects in proximity to the running Generator. This presents a fire hazard which could ignite from hot exhaust pipe assembly, fumes and vapors and result in death or extreme bodily harm to the Owner or Operator.**

WARNING

- **Maintain a proper ventilation parameter extending 914.4 mm or (3') in all directions from all manufacturer installed Generator components.**
- Verify your RV fuel gauge indicates sufficient fuel
- Verify fuel connection at Generator is secure. See [Exhibit 5](#)
- Verify Purge Line fuel vapor vent connection at the Generator is secure. See [Exhibit 5](#)
 - *In motorized applications the Purge Line will be unused. Verify manufacturer installed cap is secured on purge line spout*

D. Pre-Start Check and Inspection

D.6 Exhaust Assembly including Debris Screen See [Exhibit 2](#)

- Verify debris screen is intact
- Verify Support Strap is secure
- Verify Pipe Assembly is connected

D.7 Check Engine Air Filter Housing and Element

- Unlatch the Air Filter Housing cover
- Remove the Air Filter Element and inspect for dirt and debris
- Reinstall Air Filter Element
 - If dirt or debris is found, replace with new OEM AE002 Air Filter Element

CAUTION

- **When re-installing the Air Filter Housing, verify the cover seal is intact in its original location and the cover is latched correctly**

D.8 Ensure Overload Alarm and Oil Alert indicator lights on Generator Control Panel are off See [Exhibit 1](#)

D.9 Re-attach Generator Service Access door. See [Exhibit 1](#)

- Verify latches at the sides of the access door are both turned to "Closed"
- Close the RV Generator Compartment door and secure in place

E. Starting and Operating the Generator

E.1 Before Starting or Operating the Generator, familiarize yourself with the safety information set forth in the "A. Safety" portion of this Guide.



E.2 DANGER: Engine Exhaust

Gasoline-powered engines and tools present a serious health hazard. They produce high concentrations of carbon monoxide (CO). CO is a poisonous gas that can cause illness, permanent neurological damage and death. CO is colorless, odorless, and non-irritating and therefore can overcome exposed persons without warning. CO can rapidly accumulate (even in areas appearing to be well ventilated).

WARNING

E.3 Prior to starting the Generator and upon initial arrival at chosen destination, perform an inspection of your RV's physical location as set forth in "D. Pre-Start Check and Inspection"

E.4 After completing the Pre-Start Check and Inspection, close the Generator Service Access Door. See [Exhibit 1](#)

- Turn latches on either side of the Service Access Door and verify both are secure.

E.5 Generator Cold Start would be first start of the day, a start after eight (8) hours of inactivity or a start in below freezing temperatures

- Depress and hold Stop/Prime switch for ten (10) seconds allowing the Generator to prime the fuel pump
- Then press and hold the Start switch until the Generator starts
- Remote Control Panel's light will blink and then remain steady once the Generator is running
- Allow the Generator to run a minimum of two (2) minutes before turning on devices or appliances connected to the Generator
- The process in E.4 is exactly the same for the Remote Start/Stop Switch inside the RV and the Start/Stop Switch on the Generator Control Panel inside the Generator Service Access Door. See [Exhibit 6](#)

ATTENTION

E.6 At any time after initial Cold Start warm-up has been completed, starting and stopping the Generator may be performed by

- Start/Stop Switch on Remote Panel inside the RV. See [Exhibit 6](#)
- Start/Stop Switch inside the Generator Service Access Door. See [Exhibit 6](#)
- Integrated Pull-Start inside the Generator Service Access Door. See [Exhibit 6](#)

ATTENTION

- To manually start the Generator with the Integrated Pull Start manual operation of the choke lever inside the Service Access Door will be required

E. Starting and Operating the Generator

E.7 Wireless Hand-held Remote-Start Keyfob was created to conveniently allow you to start/stop your Generator from a distance of fifty (50) meters (164'). See [Exhibit 6](#)

- To start the Generator, press and hold the "START" button for more than one (1) second and then release the button
- To stop the Generator, press and hold the "STOP" button for more than one (1) second and then release the button

E.8 Using the Wireless Hand-held Remote-Start Keyfob for remote starting the Generator See [Exhibit 6](#)

The Keyfob you received with your RV will have its signals already matched to the Generator during installation. However, if you replace the Keyfob battery, are using a replacement Keyfob, or you lose your signal you will need to re-match the Generator and the Keyfob's wireless signals

- To match signals connect the Generator with the RV battery source, turn the Master 12 Volt Power Switch, inside the Generator Service Access Door, to the "ON" position. See [Exhibit 2](#)
- Press the Signal Match Set Button on the Remote Control Module and hold it for more than three (3) seconds until the Signal Match Indicator Light on the Remote Control Module stays on constant
- Release the Signal Match Set Button and press the "STOP" button on the Keyfob (at this moment the Signal Match Indicator Light on the Remote Control Module will blink one time and then stay on constant)
- Release the "STOP" button on the Keyfob and press the "START" button on the Keyfob (at this moment the Signal Match Indicator Light on the Remote Control Module will blink one time and then stay on constant)
- Release the "START" button on the Keyfob, press and hold the Signal Match Set Button on the Remote Control Module until the Signal Match Indicator Light on the Remote Control Module is off
- Start the Generator by pressing "START" on the Keyfob, then stop the Generator by pressing "STOP" on the Keyfob to verify the signals have matched. If the match is not made, repeat the above procedure, until the Keyfob and Generator wireless signals are successfully matched

Exhibit 6 - Generator Start Options

Hand-held Remote Start/Stop Keyfob



Stop Button

Start Button

Remote Start/Stop Switch inside RV

Start

Indicator Light

Stop/Prime



Start/Stop Switch inside Generator Service Access Door

Indicator Light

Stop/Prime

Start

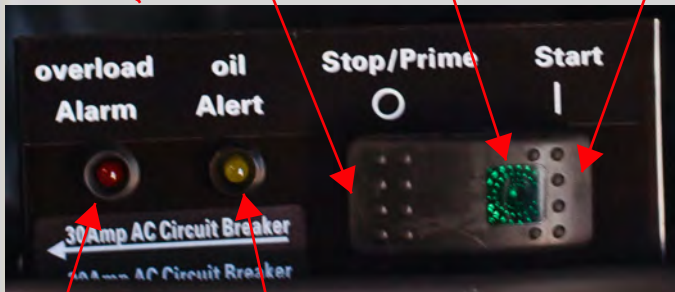

Fault Indicator Light Overload Alarm

Fault Indicator Light - Oil Alert

Emergency Pull Start Handle inside Generator Service Access Door

Remote Control Module

Signal Match Indicator Light

Signal Match Set Button

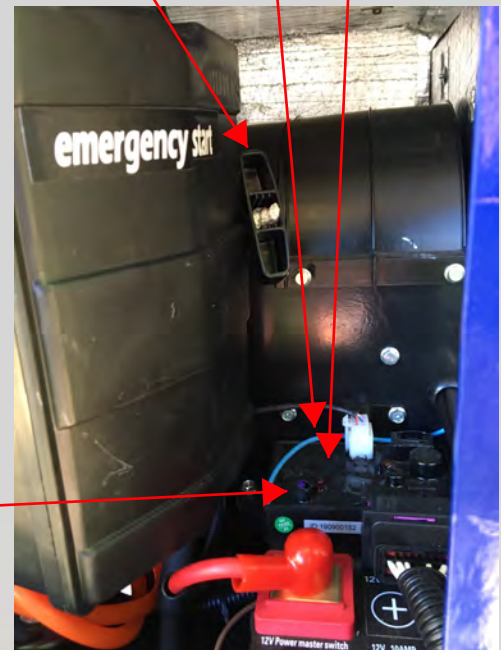

F. Maintenance Requirements

F.1 Fuel. See Yamaha MZ360 Owners Manual, at page 22

- The Generator requires unleaded gasoline with a minimum Octane of 87 or higher

F.2 Oil. See Yamaha MZ360 Owners Manual, at pages 23, 24, 32 and 36

- NPS recommends YAMALUBE 10W-40
- Generator is equipped with break-in oil. Replace oil after first twenty (20) hours of operation and at one hundred forty (140) hour intervals thereafter or one (1) time each year, whichever comes first
- Oil should be checked and replaced more frequently when operated in hot weather or dusty climates

F.3 Spark Plugs. See Yamaha MZ360 Owners Manual, at page 32

- Replace every 400 hours or sooner if engine performance drops off

F.4 Exhaust Assembly. See Yamaha MZ360 Owners Manual, at page 32

- Clean Spark Arrester and Muffler Screen at the end of the Exhaust Pipe with wire brush every forty (40) hours of operation or more frequently as needed based on visual inspections

F.5 Battery Connections

- Clean and check battery connections to ensure they are secure and free of corrosion at each initial use or monthly, whichever comes first

F.6 Air Filter Element

- Replace with new OEM AE002 Air Filter Element every one hundred forty (140) hours or more frequently when operated in dusty climates. See "D.7 - Pre-Start Check and Inspection" for a detailed replacement guide

F.7 Storing your Generator.

- If the Generator is to be stored longer than 60 days, make sure fuel tank is full of fresh fuel and fuel stabilizer has been added
- Drain the carburetor bowl. See [Exhibit 2](#)
- Verify the 12 Volt Master Power Switch is in the "OFF" position to cut off power to the Generator, so there is no draw. See [Exhibit 2](#)
- Verify the 12 Volt Master Power Switch is moved back to "ON" position when it is put back in use. See [Exhibit 2](#)

F.8 High Altitude Operation. See Yamaha MZ360 Owners Manual, at page 31

G. Troubleshooting

Generator will not start:

G.1 Generator does not crank

- Inspect battery voltage and connection to ensure adequate voltage and secure connections
 - if you have a low battery or poor connections, Generator will not turn over
- Inspect the Master 12Volt Power "ON/OFF" Switch and verify it is in the "ON" position. See [Exhibit 2](#)
 - if battery voltage is adequate and Master 12Volt Power Switch is in the "ON" position
 - Attempt to start from another starting option
 - If generator still will not crank, manually turn Automatic Choke to "FULL" and use pull start to start the Generator. See [Exhibit 2](#)
 - If still wont start, contact your dealer or NPS directly

G.2 Generator cranks but does not fire

- Inspect for adequate fuel
 - if fuel is depleted or shut off it will not start
- Inspect for spark
 - if your spark plug has carbon buildup, is fuel saturated or if ignition wire is damaged/disconnected, it will not start
- If generator has fuel and spark plug is intact and working properly and it still will not start, then contact your dealer or NPS directly

G.3 Generator is running but not powering my RV

- Check 30 amp breakers on the generator to see if they have tripped. If tripped, then reset
 - if they will not reset, then contact your dealer or NPS
- Check circuit breaker on Control Module (See [Exhibit 6](#)) to see if it has tripped. If tripped, then reset
 - if it will not reset, then contact your dealer or NPS
- Inspect the breakers and GFCI inside the RV to see if they have tripped. If tripped, then reset
 - if they will not reset or still will not power, then contact your dealer or NPS

NPS offers full support for service, warranty and technical assistance through www.NPSrvpower.com or 1-866-407-1727 during normal business hours (9:00 am - 5:00pm MST) if assistance is requested outside normal business hours, leave a message or send an email and a team member will assist you as soon as possible.

G. Troubleshooting

G.4 There are two Fault Indicator Lights on the Generator Control Panel: Overload Alarm Light and Oil Alert Light. See [Exhibit 2](#) and [Exhibit 6](#)

- Overload Alarm Light blinks rapidly when the Generator is less than five percent (5%) overloaded
 - Generator will continue running and outputting electricity
- Overload Alarm Light stays on continuously when the Generator is more than five percent (5%) overloaded
 - Generator will keep running but the Generator output will be cut off automatically within twenty (20) seconds
- Overload Alarm Light stays on when the Generator is faulty (i.e. short circuit, low voltage, over voltage, engine over speed, etc.)
 - Generator will keep running but the Generator output will be automatically cut off
- Oil Alert Light blinks when the oil level is too low. In this case, the engine will shut down automatically and the Oil Alert Light will remain illuminated.

NPS offers full support for service, warranty and technical assistance through www.NPSrvpower.com or 1-866-407-1727 during normal business hours (9:00 am-5:00pm (MST)) if assistance is requested outside normal business hours, leave a message or send an email and a team member will assist you as soon as possible.

G. Troubleshooting

G.5 Hand-held Remote-Start Keyfob is not working

- Verify the problem is not with the Generator by starting the Generator using another starting option
 - If Generator will start from another starting option but Hand-held Remote Start Keyfob still will not start or stop the Generator, then the Keyfob signal may be the problem
- Re-set Keyfob signal by performing a Signal Match
 - To match signals connect the Generator with the RV battery source, turn the Master 12 Volt Power Switch, inside the Generator Service Access Door, to the "ON" position. See Exhibit 2
 - Press the Signal Match Set Button on the Remote Control Module and hold it for more than three (3) seconds, until the Signal Match Indicator Light on the Remote Control Module stays on constant
 - Release the Signal Match Set Button and press the "STOP" button on the Keyfob (at this moment, the Signal Match Indicator Light on the Remote Control Module will blink one time and then stay on constant)
 - Release the "STOP" button on the Keyfob and press the "START" button on the Keyfob (at this moment, the Signal Match Indicator Light on the Remote Control Module will blink one time and then stay on constant)
 - Release the "START" button on the Keyfob, press and hold the Signal Match Set Button on the Remote Control Module until the Signal Match Indicator Light on the Remote Control Module is off
 - Start the Generator by pressing "START" on the Keyfob, then stop the Generator by pressing "STOP" on the Keyfob to verify the signals have matched. If the match is not made, repeat the above procedure, until the Keyfob and Generator wireless signals are successfully matched
- If your Hand-held Remote-Start Keyfob still does not work, then contact your dealer or NPS

NPS offers full support for service, warranty and technical assistance through www.NPSrvpower.com or 1-866-407-1727 during normal business hours (9:00 am-5:00pm (MST)) if assistance is requested outside normal business hours, leave a message or send an email and a team member will assist you as soon as possible.

Exhibit 7 - AC Power and Fuel Connectors

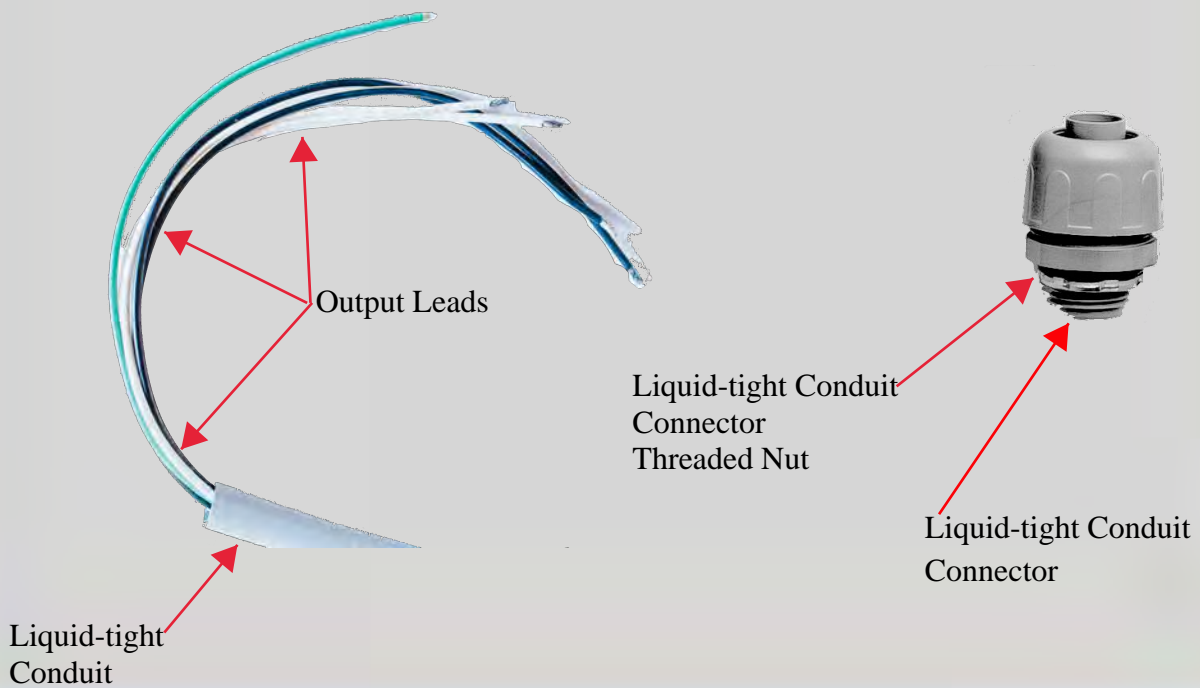
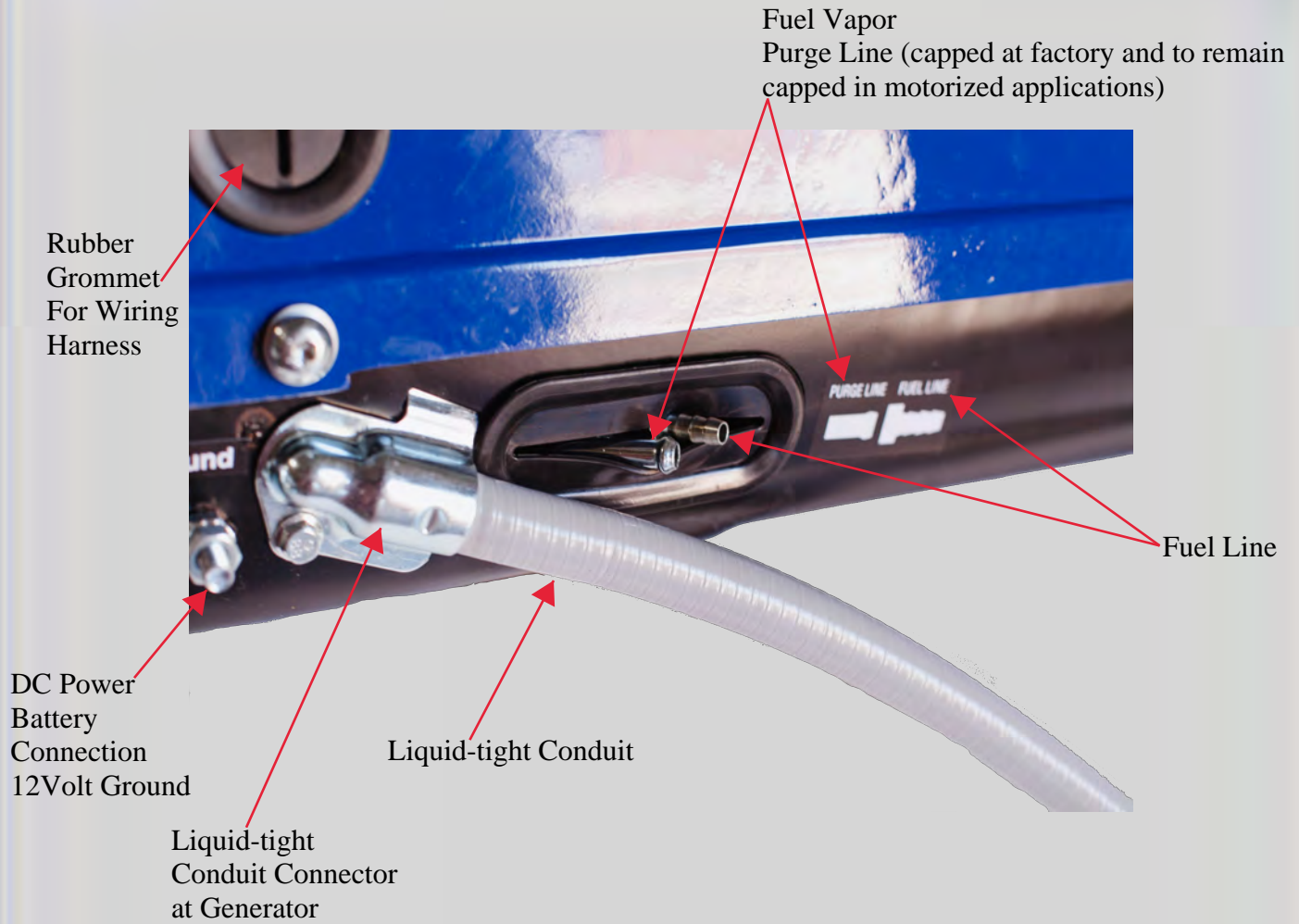
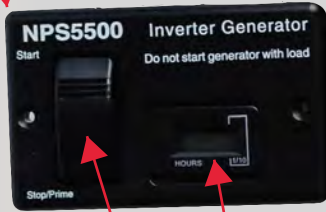

Exhibit 8 - Electrical Components

Remote Start Panel
(inside RV front view)



Start/Stop/Prime
Switch

Generator
Hours Meter

Hand-held Remote
Start/Stop Keyfob
(back view with
ID label)



Start
Button

Stop
Button



Start Button
Indicator Light

Hand-held Remote
Start/Stop Keyfob
(front view)

Remote Start
Panel
(inside RV
back view)

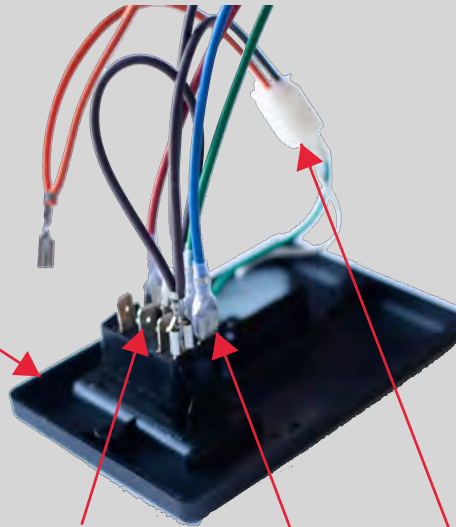

Hand-held Remote
Start/Stop Keyfob
(inside view with
battery compartment
and screws)

Wiring Harness for
Remote Start Panel

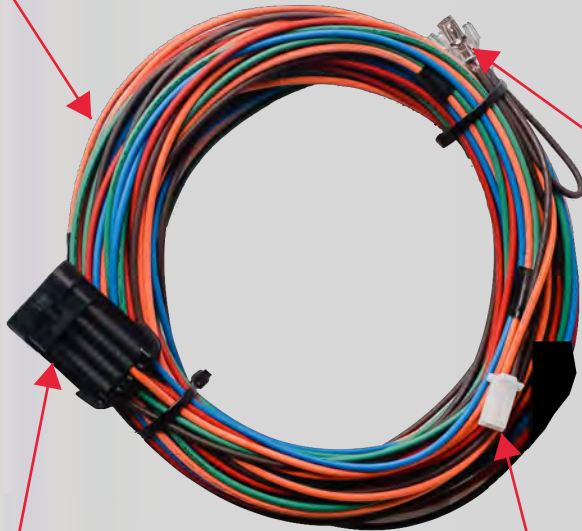

Remote Start
Panel to Wiring
Harness male
spade connectors

Generator Hours
Meter Connector
(lock-clip with green and
white wires) secured to
back of Remote Start Panel
(inside RV)

Wiring Harness to Remote
Start Panel female spade
connectors

Black female-end Connector
of Remote Start Panel
Wiring Harness for connection to
black male-end Connector
located inside Generator
Service Access Door

Wiring Harness Connector
to Generator Hours Meter
(orange and brown wires)
lock-clips to Generator Hours
Meter Connector attached to
Remote Start Panel (white and green wires)

Exhibit 9 - Wiring Harness - Remote Start Panel Connections

Top of Remote Start Panel (front)



Start Stop/Prime Switch

Generator Hours Meter

Bottom of Remote Start Panel (front)

LCI One Control System (orange jumper)

Bottom of Remote Start Panel (back side)

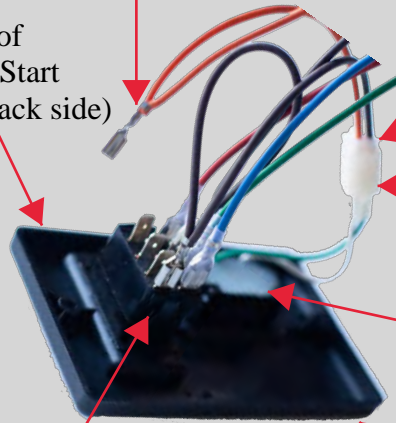

Remote Start Wiring Harness lock-clip (orange and brown wires)

Generator Hours Meter lock-clip (green and white wires, pre-installed on Remote Start Panel)

Generator Hours Meter Display

Start - Stop/Prime Switch spade connectors (diagram)

Top of Remote Start Panel (back side)

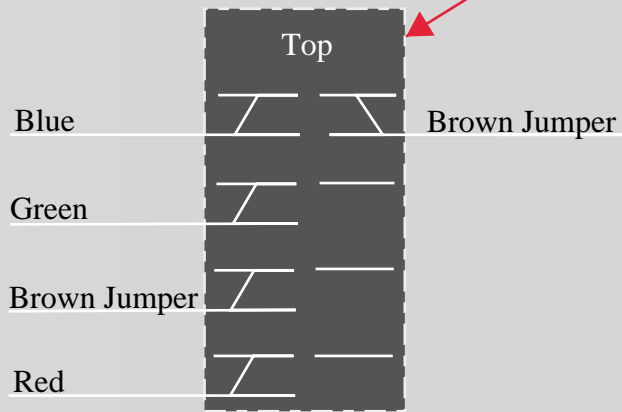

Exhibit 10 - Wiring Harness Connectors

DC Power
(12Volt red
Positive (+)
Battery Connection)

Female-end
Connector



Female-end
Connector
(wire color and
placement)

Battery Ground
(brown wire)

Stop
(green wire)

Start Light
Battery
(orange wire)

Start
(red wire)

(blue wire)

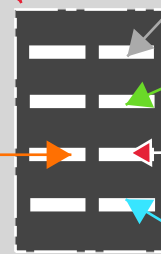

Warning
Label

DC Power
(12Volt red
Positive (+)
Battery
Connection)

Generator Service
Access Door (open)

Male-end
Connector

Start Light
Battery
(orange wire)

(blue
wire)

Start
(red wire)

Stop
(green wire)

Battery Ground
(brown wire)

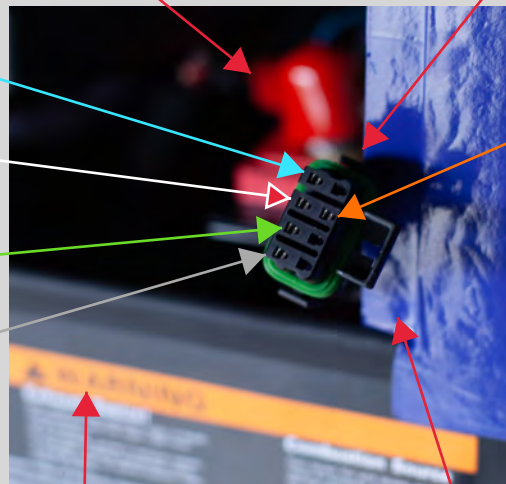

Warning
Label

Generator
Service Access
Door (open)

Exhibit 11 - Wiring Harness - Connections at Generator

Rubber Grommet with Wiring Harness threaded (inside Generator)

Generator Service Access Door (open)

Rubber Grommet for Wiring Harness (outside Generator)

Wiring Harness to Remote Start Panel

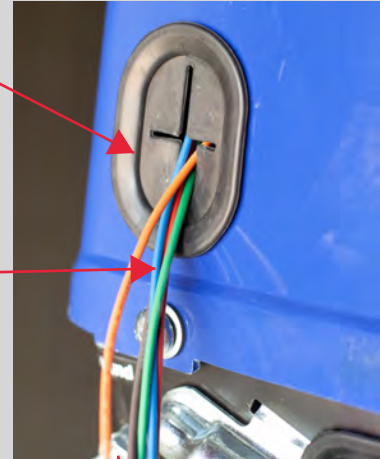

DC Power 12Volt Ground

Black female-end Connector to Remote Start Panel Wiring Harness (fully connected to male-end Connector)

Black female-end Connector to Remote Start Panel Wiring Harness (fully connected to male-end Connector)

DC Power 12Volt Circuit Breaker

Warning Label

Black male-end Connector to Generator

DC Power 12Volt Master Power Switch

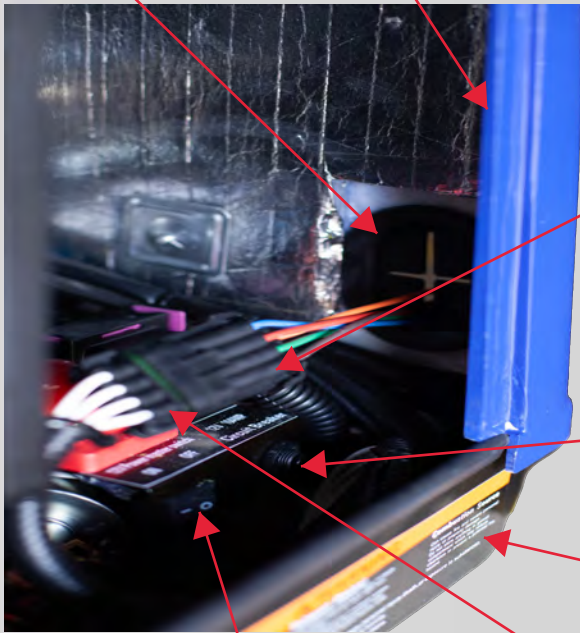

Black male-end Connector to Generator

Warning Label

H. NPS Warranty

NPS offers full support for service, warranty and technical assistance through www.NPSrvpower.com or 1-866-407-1727 during normal business hours (9:00 am - 5:00pm MST) if assistance is requested outside normal business hours, leave a message or send an email and a team member will assist you as soon as possible.

When calling or contacting NPS, please have the following information ready and available:

- Date of Purchase
- Nature of the issue you are having, See "G. Troubleshooting" section of this Guide
- Generator Model Number
- Serial Number

You may refer to [Exhibit 2](#) of this Guide for assistance in locating both the Model and Serial numbers.

**NPS Generators hold California Air Resources Board (CARB) Certification
EO U-U-017-0346 New Off-Road Small Spark Ignition Engines at or Below 19 Kilowatts**

Specifications

	<i>Y4500</i>	<i>Y5500U</i>
Inverter/Voltage Regulator:	Proprietary Pure Sine Wave Inverter	
KVA Output:	<i>4.5 KVA</i>	<i>5.0 KVA</i>
Running Watts:	<i>4,500 watts @ 3,600 RPM</i>	<i>5,000 watts @ 3,600 RPM</i>
Max Amps:	<i>41.6 Amps</i>	<i>45.8 Amps</i>
Rated Current (Amps)	<i>37.5 Amps</i>	<i>41.6 Amps</i>
Max Output:	<i>5,000 Watts</i>	<i>5,500 Watts</i>
Rated Voltage:	120 Volts	
Displacement:	21.7 in3 (357 cm3)	
Engine Type:	Air-Cooled 4-Stroke OHV	
Engine:	Yamaha MZ360KHIP3	
Weight:	185 lbs. (83.91 KG)	
Length:	29.33 in. (745 mm)	
Width:	21.46 in. (545 mm)	
Height:	16.10 in. (409 mm)	
Sound:	70 dB (A) at 10 ft (Half Load)	
Frequency:	60 Hz	

Net Power Output:	9.7 HP (7.1 kW) @ 3,600 RPM	
Net Max Power:	10.4 HP (7.6 kW) @ 3,600 RPM	
Net Torque:	18.07 lbs.-ft @ 2,500 RPM	
Compression Ratio:	8.1-1	
Carburetor:	Side Draft KY POS	
Ignition System:	Non-contact Transistor Ignition (T.C.I.)	
Auto Choke:	Electronic	
Starting System:	Wireless Remote, Wired Remote, Recoil and Electronic, 12V, 3 Wire Negative Ground	
Fuel Consumption:	.58 Gal/Hr.	.64 Gal/Hr.
Fuel Type:	Unleaded Gas	Unleaded Gas
Pull Start:	Yes	Yes
Remote Key Fob:	Yes	Yes
Auto Choke:	Electronic	
Lubrication System:	Oil Splash	

Exhibit 12 - Wiring Diagram

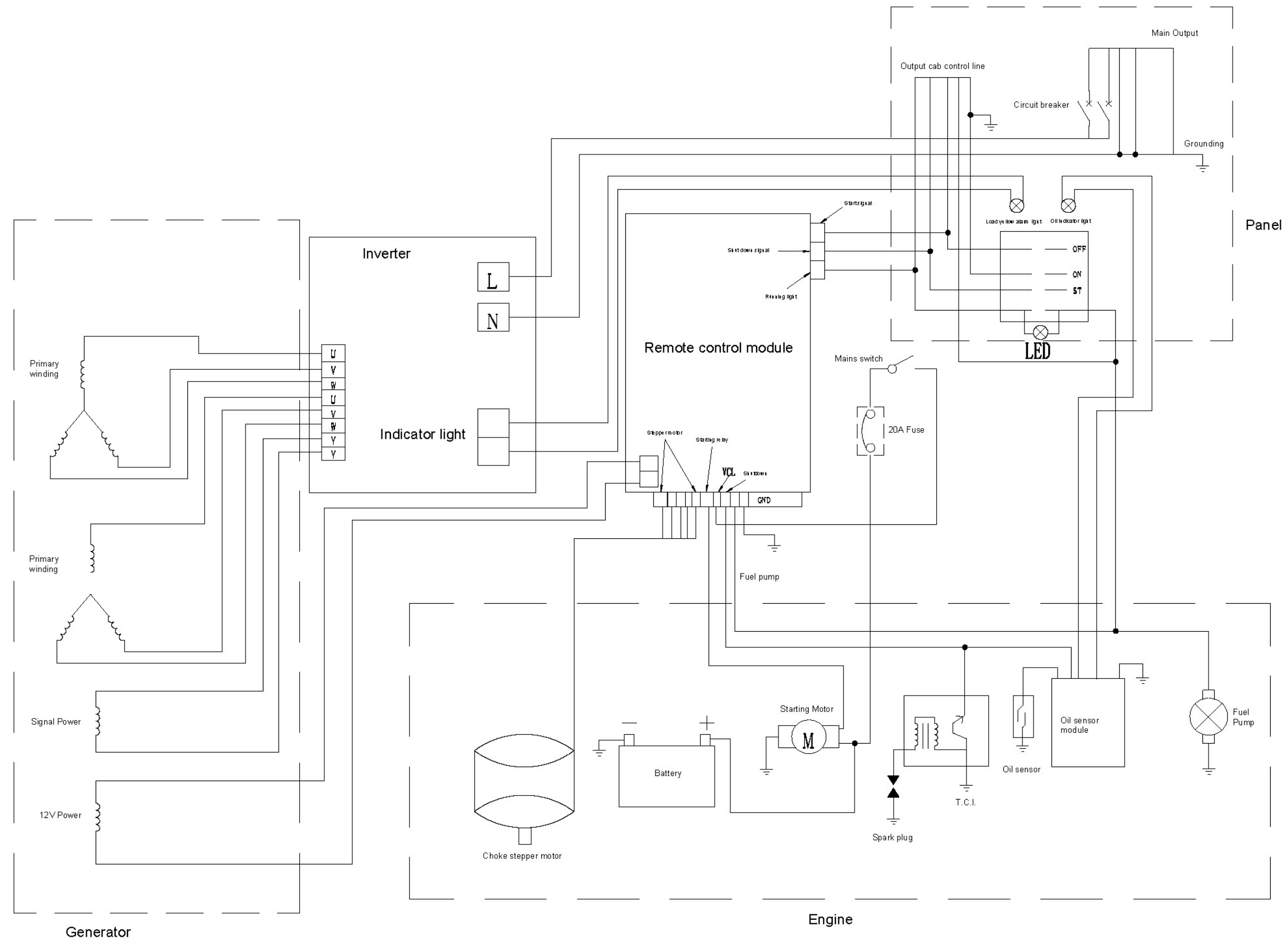

Exhibit 13 - Generator Installation Bracket Floor Cut-out Template (measurements are in millimeters)

